

Reference manual
Temperature Calibrator
Jofra ETC-125 A / 400 A / 400 R



User- and Reference manual

Temperature Calibrator

JOFRA ETC-125 A / 400 A / 400 R

© Copyright 2005 AMETEK Denmark A/S (123943-UK)



About this manual....

- **The structure of the user- and reference manual**

The user manual sets out the operating instructions for the instrument. It is designed to provide a quick reference guide for use in the field.

The reference manual is aimed at users who are familiar with AMETEK calibrators, as well as those who are not. The manual is divided into 10 chapters which describe how to set up, operate, service and maintain the calibrator. The technical specifications are described and accessories may be ordered from the list of accessories.

- **Safety symbols**

This manual contains a number of safety symbols designed to draw your attention to instructions which must be followed when using the instrument, as well as any risks involved.



Warning

Conditions and actions that may compromise the safe use of the instrument and result in considerable personal injury or material damage.



Caution...

Conditions and actions that may compromise the safe use of the instrument and result in slight personal or material damage.



Note...

Special situations which demand the user's attention.

List of contents

..... **User manual, English**

..... **Reference manual, English**

User manual

Temperature Calibrator

JOFRA ETC-125 A / 400 A / 400 R

© Copyright 2005 AMETEK DENMARK A/S (123943-UK)



FIG. 1

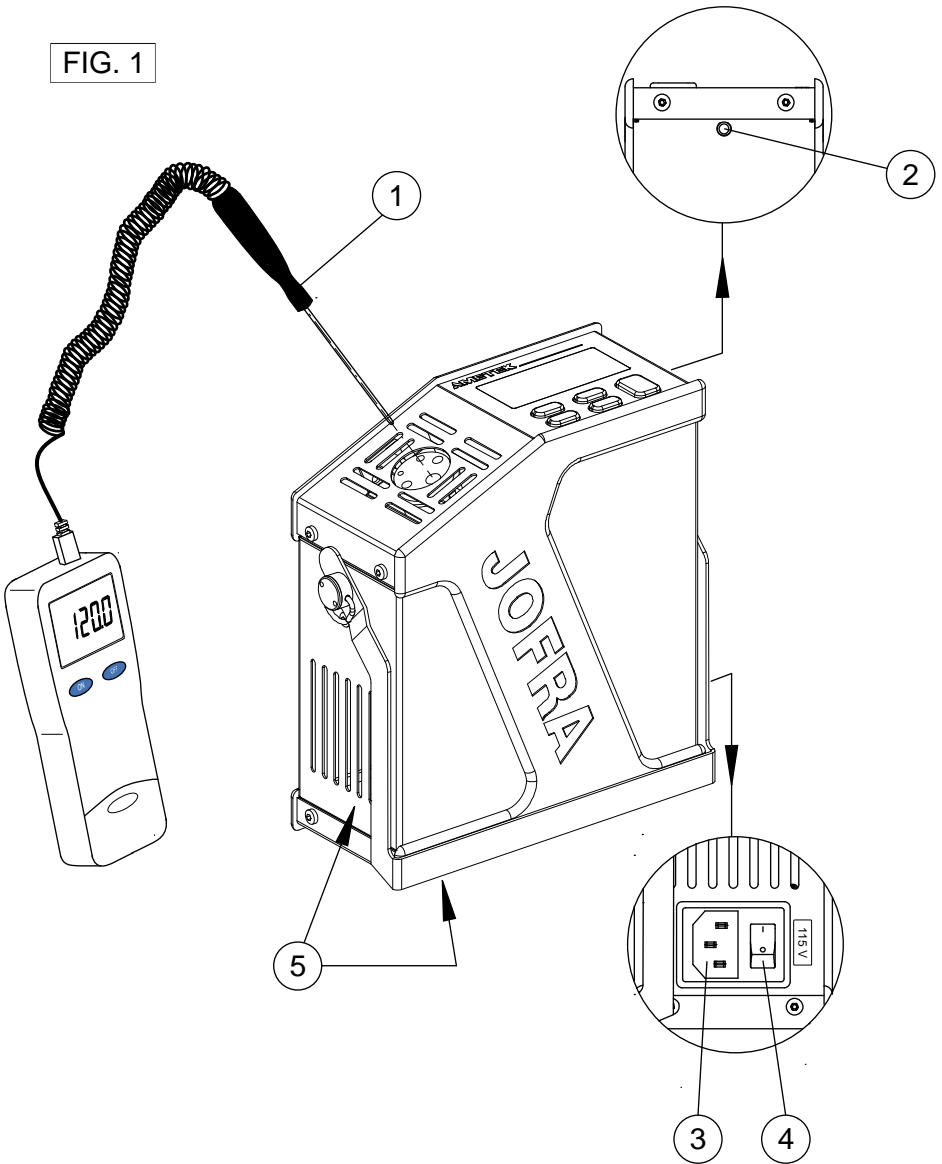

FIG. 2

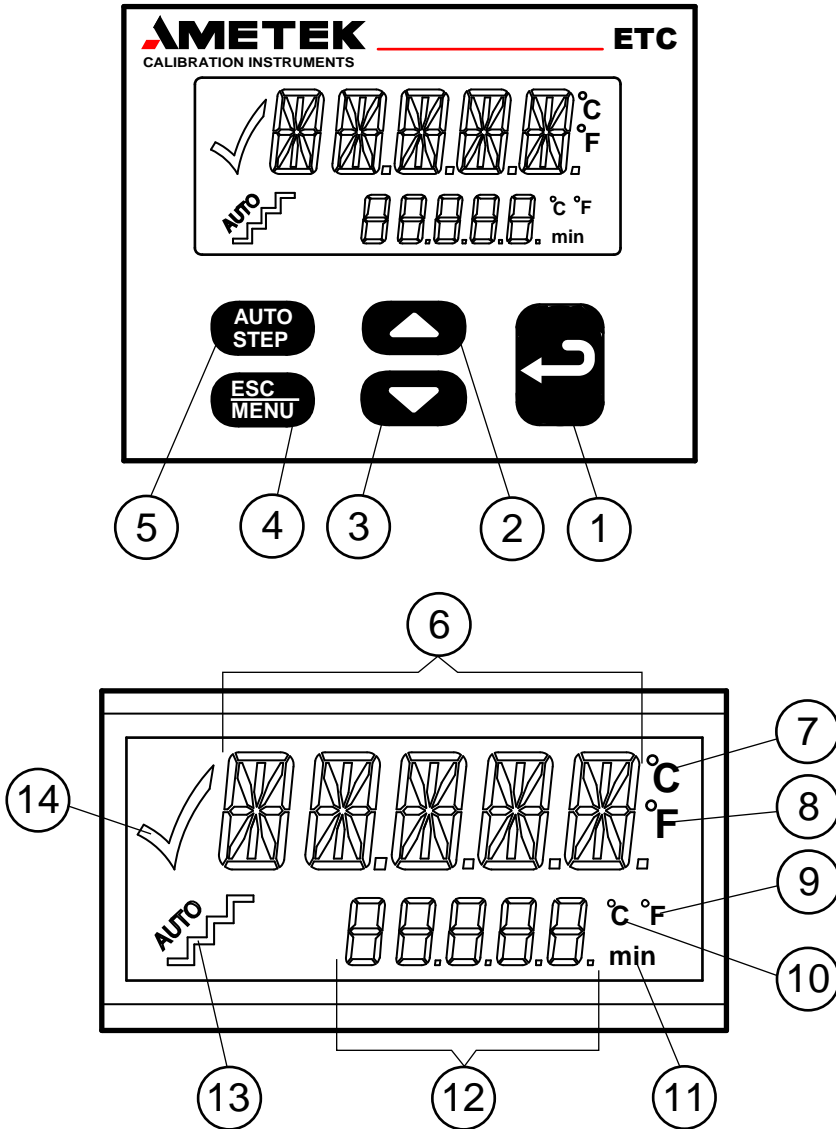

FIG. 3

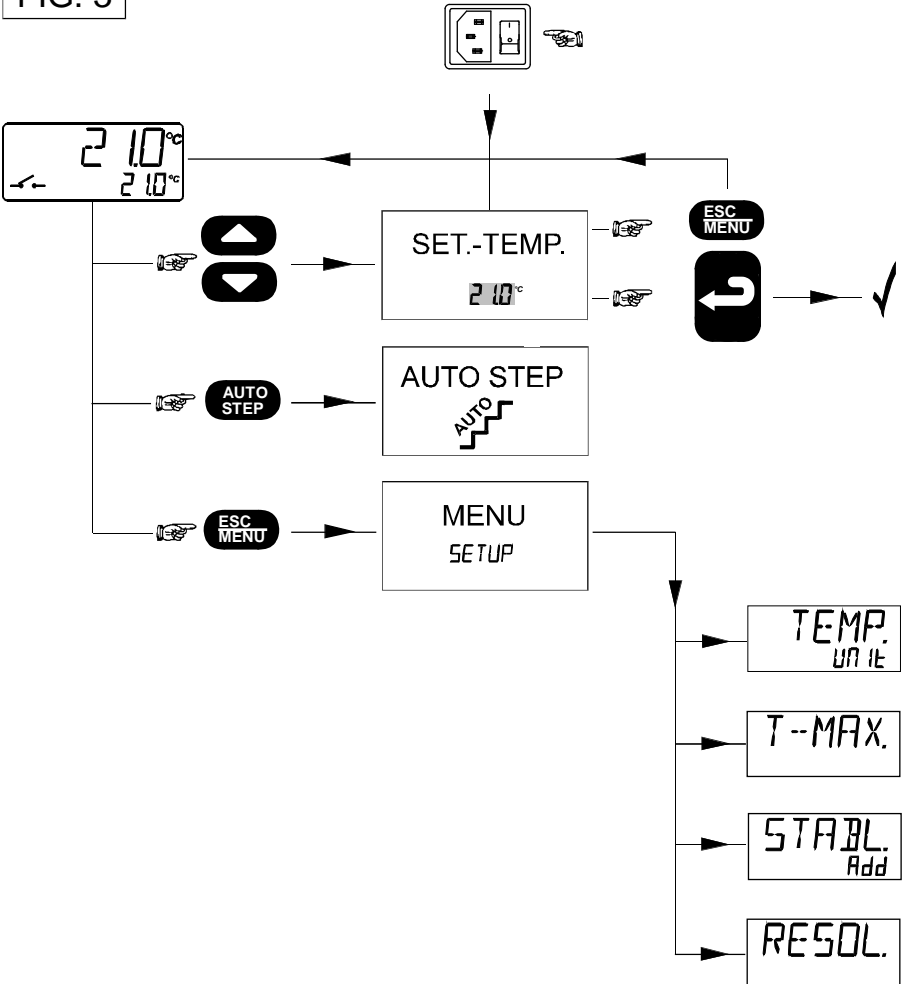

FIG. 4

**AUTO
STEP**

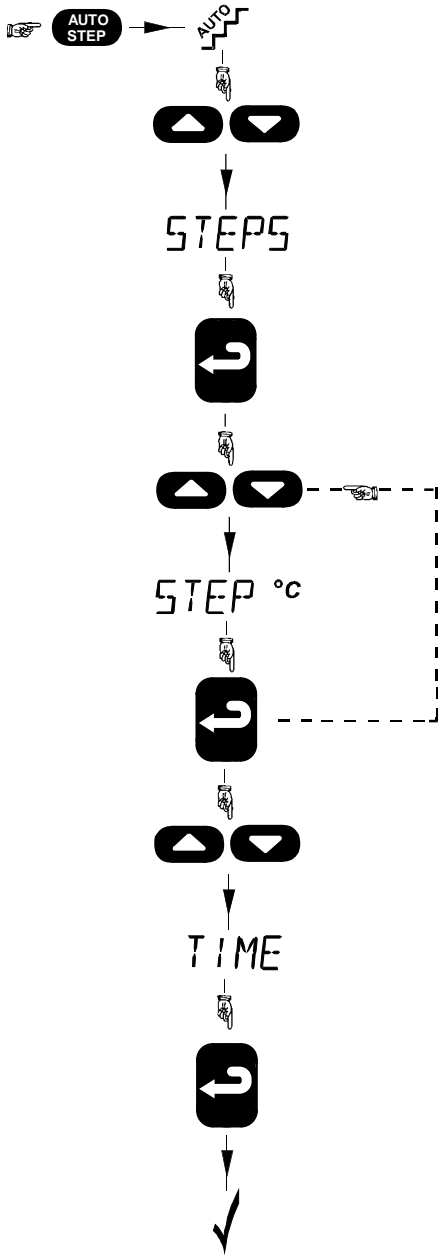
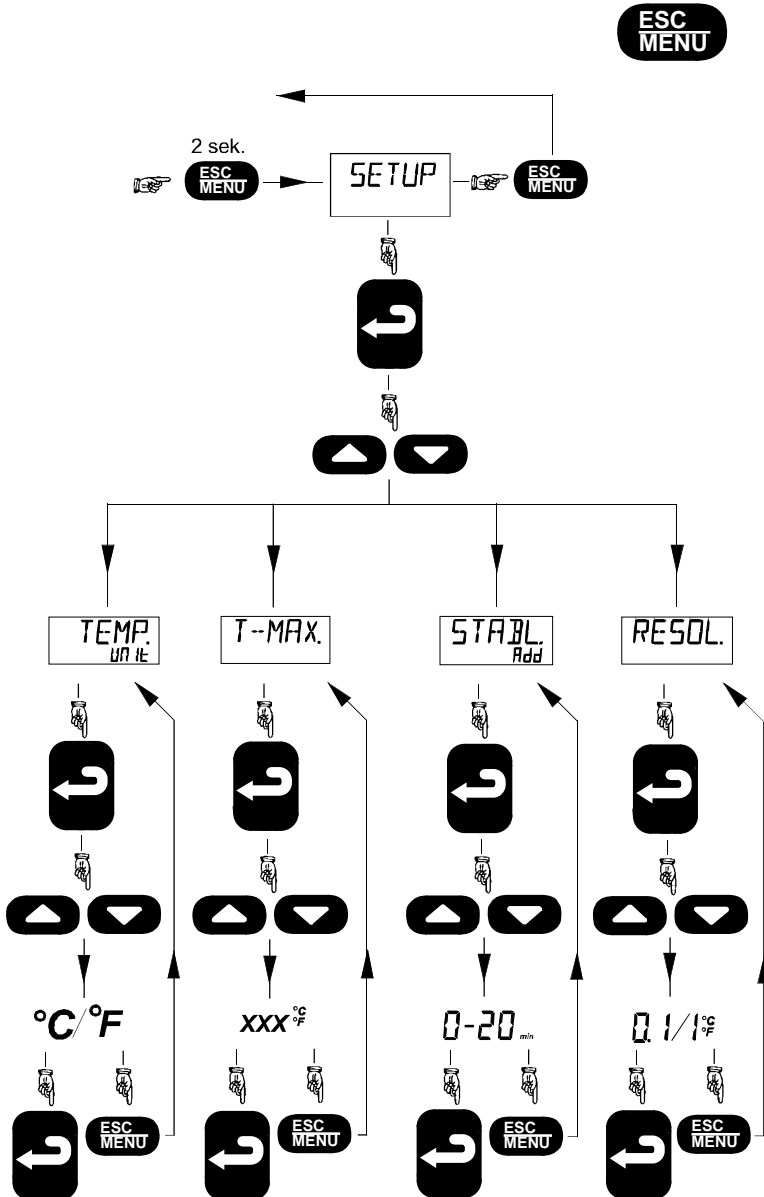

FIG. 5



List of contents

1.0	Introduction.....	2
2.0	Safety instructions	3
3.0	Operating the calibrator	7
3.1	Before use.....	7
3.2	Keyboard.....	10
3.3	Display	10
3.4	Connections	11
3.5	Calibrator functions - overview.....	11
3.6	Selecting the set-temperature.....	11
3.7	AUTO STEP	12
3.8	MENU.....	13
4.0	After use.....	14
4.1	Switching off the calibrator.....	15

1.0 Introduction

ETC-calibrators are temperature calibrators designed to calibrate temperature sensors.

Read this manual carefully before using the instrument and make sure that all safety instructions and warnings are observed.

2.0 Safety instructions



Read this manual carefully before using the instrument!

In order to avoid any personal injuries and/or damage to the instrument all safety instructions and warnings must be observed.



Disposal – WEEE Directive

These calibrators contain Electrical and Electronic circuits and must be recycled or disposed of properly (in accordance with the WEEE Directive 2002/96/EC).



Warning

About the use:

- The calibrator **must not** be used for any purposes other than those described in this manual, as it might cause a hazard.
- The calibrator has been designed for **indoor use only** and is not to be used in wet locations.
- The calibrator is **not to be used in hazardous areas**, where vapour or gas leaks, etc. may constitute a danger of explosion.
- The calibrator is **not** designed for operation in altitudes above 2000 meters.
- The calibrator is a CLASS I product and must be connected to a mains outlet with a protective earth connection. Ensure the ground connection of the calibrator is properly connected to the protective earth before switching on the calibrator. Always use a mains power cable with a mains plug that connects to the protective earth.

- To ensure the connection to protective earth any extension cord used **must** also have a protective earth conductor.
- Only use a mains power cord with a current rating as specified by the calibrator and which is approved for the voltage and plug configuration in your area.
- Before switching on the calibrator make sure that it is set to the voltage of the mains electricity supply.
- **Always** position the calibrator to enable easy and quick disconnection of the power source (mains inlet socket).
- The calibrator **must** be kept clear within an area of 20 cm on all sides and 1 metre above the calibrator due to fire hazard.
- **Never** use heat transfer fluids such as silicone, oil, paste, etc. in the calibrators. These fluids may penetrate the calibrator and cause electrical hazard, damage or create poisonous fumes.
- The calibrator **must** be switched off before any attempt to service the instrument is made. There are no user serviceable parts inside the calibrator.
- When cleaning the well or insertion tube, **REMEMBER** to wear goggles when using compressed air!

About the insertion tubes and well:

- **Never** leave hot insertion tubes which have been removed from the calibrator unsupervised – they may constitute a fire hazard or personal injury.
- If you intend to store the calibrator in the optional aluminium carrying case after use, you **must** ensure that the instrument has cooled down to a temperature **below 100°C/212°F** before placing it in the carrying case.
- Never place a hot insertion tube in the optional carrying case.



Caution – Hot surface

- **Do not touch** the well, the insertion tube or the grid plate, as the calibrator is heating up / has been heated up – they may be very hot and cause burns.
- **Do not touch** the tip of the sensor when it is removed from the insertion tube/well – it may be very hot and cause burns.
- **Over 50°C/122°F**
If the calibrator has been heated up to temperatures above 50°C/122°F, you must wait until the instrument reaches a temperature **below 50°C/122°F** before you switch it off.
- **Do not** remove the insert from the calibrator before the insert has cooled down to less than 50°C/122°F.



Caution – Cold surface

Below 0°C/32°F (applies only to the ETC-125 A models)

- **Do not** touch the well or insertion tube when these are below 0°C/32°F - they might create frostbite.
- If the calibrator has reached a temperature below 0°C/32°F, ice crystals may form on the insertion tube and the well. This, in turn, may cause the material surfaces to oxidize
To prevent this from happening, simply heat up the calibrator to 100°C/212°F until all water left has evaporated.
It is very important that humidity in the well and insertion tube is removed to prevent corrosion and frost expansion damages.



Caution...

About the use:

- **Do not** use the instrument if the fan is out of order.
- Before cleaning the calibrator, you **must** switch it off, allow it to cool down and remove all cables.

About the well, insertion tube and grid plate:

- The well and the insertion tube **must** be clean before use.
- **Do not** pour any form of liquids into the well. It might damage the well or cause a hazard.
- Scratches and other damage to the insertion tubes should be avoided by storing the insertion tubes carefully when not in use.
- The insertion tube must **never** be forced into the well. The well could be damaged as a result, and the insertion tube may get stuck.
- The insertion tube must **always** be removed from the calibrator after use.
The humidity in the air may cause corrosion oxidation on the insertion tube inside the instrument. There is a risk that the insertion tube may get stuck if this is allowed to happen.



Note...

The product liability **only** applies if the instrument is subject to a manufacturing defect. This liability becomes void if the user fails to follow the instructions set out in this manual or uses unauthorised spare parts.

3.0 Operating the calibrator

3.1 Before use



Warning

- The calibrator **must not** be used for any purposes other than those described in this manual, as it might cause a hazard.
- The calibrator has been designed for **indoor use only** and is not to be used in wet locations.
- The calibrator is **not to be used in hazardous areas**, where vapour or gas leaks, etc. may constitute a danger of explosion.
- The calibrator is **not** designed for operation in altitudes above 2000 meters.
- The calibrator is a CLASS I product and must be connected to a mains outlet with a protective earth connection. Ensure the ground connection of the calibrator is properly connected to the protective earth before switching on the calibrator. Always use a mains power cable with a mains plug that connects to the protective earth.
- To ensure the connection to protective earth any extension cord used **must** also have a protective earth conductor.
- Only use a mains power cord with a current rating as specified by the calibrator and which is approved for the voltage and plug configuration in your area.
- Before switching on the calibrator make sure that it is set to the voltage of the mains electricity supply.
- **Always** position the calibrator to enable easy and quick disconnection of the power source (mains inlet socket).
- The calibrator **must** be kept clear within an area of 20 cm on all sides and 1 metre above the calibrator due to fire hazard.

- **Never** use heat transfer fluids such as silicone, oil, paste, etc. in the calibrators. These fluids may penetrate the calibrator and cause electrical hazard, damage or create poisonous fumes.



Caution – Hot surface

- **Do not touch** the grid plate, the well or the insertion tube as the calibrator is heating up – they may be very hot and cause burns.
- **Do not touch** the handle of the calibrator during use – it may be very hot and cause burns.

Follow the instructions below before using the calibrator (cf. Fig. 1):

1. Place the calibrator on an even horizontal surface away from all draughts.



Caution...

Do not use the instrument if the fan is out of order. Ensure a free supply of air to the fan (pos. 5).

2. Check that the voltage shown on the label above the power control switch is identical to the mains voltage (ETC-400 only). If not, the instrument should be returned to AMETEK Denmark A/S or the distributor for replacement.
3. Plug in the cable below (pos. 3) the power control switch (pos. 4) and check that the earth connection is present.
4. The selected insertion tube is inserted into the calibrator (ETC-125 A only).



Caution...

- The well and the insertion tube **must** be clean before use.
- The insertion tube must **never** be forced into the well. The well could be damaged as a result, and the insertion tube may get stuck.
- **Do not** pour any form of liquids into the well. It might damage the well or cause a hazard.

5. Place the sensor (pos. 1, Fig. 1).

3.2 Keyboard

The keys on the keyboard activate the following functions (cf. Fig. 2):

POS	Description
①	ENTER button used to accept chosen options.
②	UP ARROW button used to adjust temperature values (value increases) and to select menu options.
③	DOWN ARROW button used to adjust temperature values (value decreases) and to select menu options.
④	ESC/MENU button used to escape or to activate the menu system (hold button down for min. 2 seconds).
⑤	AUTO STEP button used to activate AUTO STEP. The function is used to switch between a series of set-temperatures automatically.

3.3 Display

The various segments of the display are used to indicate the following (cf. Fig. 2):

POS	Description
⑥	Used to display Read-temperature and parameters in the menu system.
⑦	Celsius temperature unit for top display.
⑧	Fahrenheit temperature unit for top display.
⑨	Fahrenheit temperature unit for bottom display.
⑩	Celsius temperature unit for bottom display.
⑪	Minute time unit for bottom display.
⑫	Used to display set-temperature, time-until-stable and parameter values in the menu system.

- ⑬ AUTO STEP symbol used to indicate that the function is active (symbol flashes repeatedly).
- ⑭ Check mark displayed when the calibrator is stable.

3.4 Connections









The instrument is designed for the following connections (cf. Fig. 1):

POS	Description
②	Connection of RS232 cable

3.5 Calibrator functions - overview

The instrument's functions are divided into hierarchical groups. See the key diagram in Fig. 3.













3.6 Selecting the set-temperature

-  Press  or . The current set-temperature flashes (the starting point is the last chosen set-temperature even if the instrument has been turned off).
-  Press  or  to select the required temperature.
-  Press  to accept the change or  to cancel and return to the previous value.

The calibrator will now work towards the new set-temperature.

3.7 AUTO STEP

The AUTO STEP function (cf. Fig. 4) is used to step automatically between a range of different set-temperatures.



- ➔ Press . The instrument displays the number of set-temperature *STEPS*.
- ➔ Press  or  to select the required number of steps.
- ➔ Press  to accept your selection. The first set-temperature will flash.
- ➔ Press  or  to select the required temperature.
- ➔ Press  to accept your selection. The next set-temperature will flash. This process will be repeated until the last value has been accepted. The extra *TIME* for which you wish the calibrator to remain at every step will flash.
- ➔ Press  or  to set the required number of minutes.
- ➔ Press  to accept your selection. The function will be activated.
- ➔ Press  after the last set-temperature to end the function or  to leave the function at any time.

3.8 MENU

The MENU function (cf. Fig. 5) is used to modify the SETUP parameters.

➔ Hold down  for approx. 2 seconds. The word *SETUP* will appear on the display.

➔ Press . The first SETUP parameter will be displayed.

➔ Press  or  to toggle between the SETUP parameters:

TEMP. UNIT: Temperature unit °C or °F.



T-MAX.: The highest permissible temperature for the calibrator.

STABL. Add: Extra time which must elapse once the well is stable before the check mark symbol is displayed.

RESOL.: Temperature resolution of 0 or 1 decimal.

➔ Press  to select the SETUP parameter you wish to change. The current value will flash.

➔ Press  or  to select the required value.

➔ Press  to accept your selection or  to cancel and return to the previous value.

➔ Once you have changed all SETUP parameters as required, cancel the function by pressing  twice.

4.0 After use



Caution – Hot surface

- **Do not touch** the well, the insertion tube or the grid plate - they may be very hot and cause burns.
- **Do not touch** the tip of the sensor when it is removed from the insertion tube/well – it may be very hot and cause burns.
- **Over 50°C/122°F**

If the calibrator has been heated up to temperatures above 50°C/122°F, you must wait until the instrument reaches a temperature **below 50°C/122°F** before you switch it off.

ETC-125 A only.



Warning.....

- **Never** leave hot insertion tubes which have been removed from the calibrator unsupervised – they may constitute a fire hazard or personal injury.
- **Do not** remove the insertion tube from the calibrator before the insertion tube has cooled down to less than 50°C/122°F.



Caution...

- The insertion tube must **always** be removed from the calibrator after use.

The humidity in the air may cause corrosion oxidation on the insertion tube inside the instrument. There is a risk that the insertion tube may get stuck if this is allowed to happen.

- If the calibrator is to be transported, the insertion tube **must** be removed from the well to avoid damage to the instrument.

- Scratches and other damage to the insertion tubes should be avoided by storing the insertion tubes carefully when not in use.

4.1 Switching off the calibrator

The following routine must be observed before the insertion tube is removed and the instrument turned off (cf. Fig. 1) :

1. If the calibrator has been heated up to temperatures above 50°C/122°F, you must wait until the instrument reaches a temperature **below 50°C/122°F** before you switch it off.
2. If the calibrator has reached a temperature below 0°C/32°F, it should be heated momentarily to a temperature of 100°C/212°F.
3. Turn off the calibrator using the power control switch (pos. 4).
4. Remove the insertion tube from the calibrator using the tool supplied with the instrument.

Reference manual

Temperature Calibrator

JOFRA ETC-125 A / 400 A / 400 R

© Copyright 2005 AMETEK Denmark A/S (123943-UK)



List of contents

1.0	Introduction	4
1.1	Warranty	5
2.0	Safety instructions	6
3.0	Setting up the calibrator	10
3.1	Receipt of the calibrator	10
3.2	Preparing the calibrator.....	12
3.3	Choice of insertion tube / correct bore in well.....	14
3.4	Inserting the sensor	16
4.0	Operating the calibrator.....	18
4.1	Keyboard, display and connections	18
4.2	Starting the calibrator	21
4.3	Selecting the set-temperature.....	21
4.4	Using the AUTO STEP	23
4.5	Using the MENU	26
4.5.1	Adjusting the temperature unit	27
4.5.2	Adjusting the max-temperature.....	28
4.5.3	Adjusting the extra stability time.....	28
4.5.4	Adjusting the temperature resolution	29
4.6	Calibrating IR-thermometers (ETC-400 R only).....	30
4.7	Simulation/training	33
5.0	Storing and transporting the calibrator	34
6.0	Errors	37
7.0	Returning the calibrator for service.....	39
8.0	Maintenance	41
8.1	Cleaning.....	41
8.2	Adjusting and calibrating the instrument.....	44
8.2.1	Adjusting the calibration date	46
8.2.2	Calibrating/adjusting the instrument.....	47
8.2.3	Calibrating/adjusting the ETC-400 R.....	51
9.0	Technical specifications	52
10.0	List of accessories.....	58

1.0 Introduction

Congratulations on your new AMETEK Jofra ETC Calibrator!

With the AMETEK Jofra calibrator, you have chosen an extremely effective instrument which we hope will live up to all your expectations. Over the past many years, we have acquired extensive knowledge of industrial temperature calibration. This expertise is reflected in our products which are all designed for daily use in an industrial environment. Please note that we would be very interested in hearing from you if you have any ideas or suggestions for changes to our products.

This reference manual applies to the following instruments:

- **Jofra ETC-125 A**
- **Jofra ETC-400 A**
- **Jofra ETC-400 R**

ISO-9001 certified

AMETEK Denmark A/S was ISO-9001 certified in September 1994 by Bureau Veritas Certification Denmark.

CE-label



Your new temperature calibrator bears the CE label and conforms to the Electromagnetic Compatibility (EMC) Directive 2014/30/EU and the Low Voltage Directive 2014/35/EU and RoHS Recast (RoHS II) Directive 2011/65/EU*.

* ETC-125 A from serial no. xxxxxx-01328, ETC-400 A / ETC-400 R from serial no. xxxxxx-01798

Technical assistance

Please contact the dealer from whom you acquired the instrument if you require technical assistance.

1.1 Warranty

This instrument is warranted against defects in workmanship, material and design for two (2) years from date of delivery to the extent that AMETEK will, at its sole option, repair or replace the instrument or any part thereof which is defective, provided, however, that this warranty shall not apply to instruments subjected to tampering or, abuse, or exposed to highly corrosive conditions.

THIS WARRANTY IS IN LIEU OF ALL OTHER WARRANTIES WHETHER EXPRESS OR IMPLIED AND AMETEK HEREBY DISCLAIMS ALL OTHER WARRANTIES, INCLUDING, WITHOUT LIMITATION, ANY WARRANTY OF FITNESS FOR A PARTICULAR PURPOSE OR MERCHANTABILITY. AMETEK SHALL NOT BE LIABLE FOR ANY INCIDENTAL OR CONSEQUENTIAL DAMAGES, INCLUDING, BUT NOT LIMITED TO, ANY ANTICIPATED OR LOST PROFITS.

This warranty is voidable if the purchaser fails to follow any and all instructions, warnings or cautions in the instrument's User Manual.

If a manufacturing defect is found, AMETEK will replace or repair the instrument or replace any defective part thereof without charge; however, AMETEK's obligation hereunder does not include the cost of transportation, which must be borne by the customer. AMETEK assumes no responsibility for damage in transit, and any claims for such damage should be presented to the carrier by the purchaser.

2.0 Safety instructions



Read this manual carefully before using the instrument!

Please follow the instructions and procedures described in this manual. They are designed to allow you to get the most out of your calibrator and avoid any personal injuries and/or damage to the instrument.



Disposal – WEEE Directive

These calibrators contain Electrical and Electronic circuits and must be recycled or disposed of properly (in accordance with the WEEE Directive 2002/96/EC).



Warning

About the use:

- The calibrator **must not** be used for any purposes other than those described in this manual, as it might cause a hazard.
- The calibrator has been designed for **indoor use only** and is not to be used in wet locations.
- The calibrator is **not to be used in hazardous areas**, where vapour or gas leaks, etc. may constitute a danger of explosion.
- The calibrator is a CLASS I product and must be connected to a mains outlet with a protective earth connection. Ensure the ground connection of the calibrator is properly connected to the protective earth before switching on the calibrator. Always use a mains power cable with a mains plug that connects to the protective earth.
- To ensure the connection to protective earth any extension cord used **must** also have a protective earth conductor.

- Only use a mains power cord with a current rating as specified by the calibrator and which is approved for the voltage and plug configuration in your area.
- Before switching on the calibrator make sure that it is set to the voltage of the mains electricity supply.
- **Always** position the calibrator to enable easy and quick disconnection of the power source (mains inlet socket).
- The calibrator **must** be kept free within an area of 20 cm on all sides and 1 metre above the calibrator due to fire hazard.
- **Never** use heat transfer fluids such as silicone, oil, paste, etc. in the calibrators. These fluids may penetrate the calibrator and cause electrical hazard, damage or create poisonous fumes.
- The calibrator **must** be switched off before any attempt to service the instrument is made. There are no user serviceable parts inside the calibrator.
- When cleaning the well or the insertion tube, **REMEMBER** to wear goggles when using compressed air in the dry-block calibrator.
- **Avoid** knocking, bumping or dropping the instrument. This can cause permanent damage to the instrument and loss of accuracy.
- **Do not** use this instrument for any application other than calibration work.
- The calibration instruments should only be used by TRAINED PERSONNEL.

About the insertion tubes and well:

- **Never** leave hot insertion tubes which have been removed from the calibrator unsupervised – they may constitute a fire hazard or personal injury.
- If you intend to store the calibrator in the optional aluminium carrying case after use, you **must** ensure that the instrument has cooled down to a temperature **below 100°C/212°F** before placing it in the carrying case.

- Never place a hot insertion tube in the optional carrying case.



Caution – Hot surface

This symbol is engraved in the well of the ETC-400 A and in the grid plate of the ETC-125 A / 400 R.



- **Do not touch** the well, the insertion tube or the grid plate, as the calibrator is heating up / has been heated up – they may be very hot and cause burns.
- **Do not touch** the tip of the sensor when it is removed from the insertion tube/well – it may be very hot and cause burns.
- **Over 50°C/122°F**
If the calibrator has been heated up to temperatures above 50°C/122°F, you must wait until the instrument reaches a temperature **below 50°C/122°F** before you switch it off.
- **Do not** remove the insert from the calibrator before the insert has cooled down to less than 50°C/122°F.



Caution – Cold surface

Below 0°C/32°F (applies only to the ETC-125 A models)

- **Do not** touch the well or insertion tube when these are below 0°C/32°F - they might create frostbite.
- If the calibrator has reached a temperature below 0°C/32°F, ice crystals may form on the insertion tube and the well. This, in turn, may cause the material surfaces to oxidize
To prevent this from happening, simply heat up the calibrator to 100°C/212°F until all water left has evaporated.

It is very important that humidity in the well and insertion tube is removed to prevent corrosion and frost expansion damages.



Caution...

About the use:

- **Do not** use the instrument if the fan is out of order.
- Before cleaning the calibrator, you **must** switch it off, allow it to cool down and remove all cables.

About the well, insertion tube and grid plate:

- The well and the insertion tube **must** be clean before use.
- **Do not** pour any form of liquids into the well. It might damage the well or cause a hazard.
- Scratches and other damage to the insertion tubes should be avoided by storing the insertion tubes carefully when not in use.
- The insertion tube must **never** be forced into the well. The well could be damaged as a result, and the insertion tube may get stuck.
- The insertion tube must **always** be removed from the calibrator after use.
The humidity in the air may cause corrosion oxidation on the insertion tube inside the instrument. There is a risk that the insertion tube may get stuck if this is allowed to happen.



Note...

The product liability **only** applies if the instrument is subject to a manufacturing defect. This liability becomes void if the user fails to follow the maintenance instructions set out in this manual or uses unauthorised spare parts.

3.0 Setting up the calibrator

3.1 Receipt of the calibrator

When you receive the instrument...

- Carefully unpack and check the calibrator and the accessories.
- Check the parts off against the list shown below.

If any of the parts are missing or damaged, please contact the dealer who sold the calibrator.

You should receive:

- 1 calibrator
-

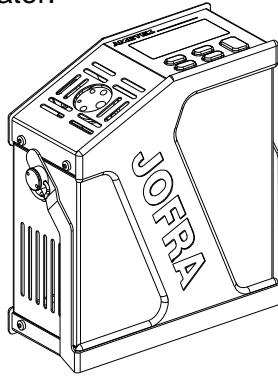

- 1 mains power cable
-

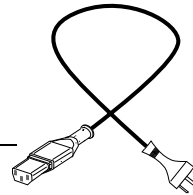

- 1 insertion tube (ETC-125 A only)
-

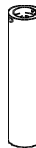

- 1 tool for insertion tube (ETC-125 A only)
-

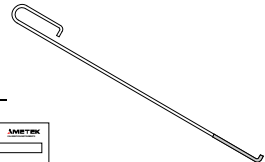

- 1 traceable calibration certificate
-

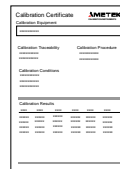

- 1 RS 232 serial cable
-

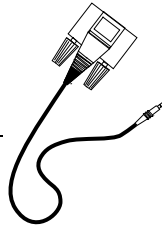

- 1 shoulder strap
-

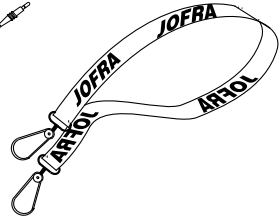

- 1 USB-key containing User-/Reference manual and software package "JOFRACAL"
-



- 1 USB-key containing JOFRA IR-LAB calibration software (ETC-400 R only)
-



- 1 correction table for emissivity (ETC-400 R only)
-

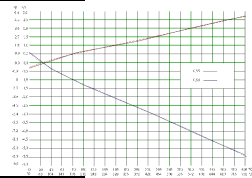

When reordering, please specify the parts number found in the list of accessories, section 10.0.

3.2 Preparing the calibrator



Warning

- The calibrator has been designed for **indoor use only** and is not to be used in wet locations.
- The calibrator is **not to be used in hazardous areas**, where vapour or gas leaks, etc. may constitute a danger of explosion.
- The calibrator is **not** designed for operation in altitudes above 2000 meters.
- The calibrator is a CLASS I product and must be connected to a mains outlet with a protective earth connection. Ensure the ground connection of the calibrator is properly connected to the protective earth before switching on the calibrator. Always use a mains power cable with a mains plug that connects to the protective earth.
- To ensure the connection to protective earth any extension cord used **must** also have a protective earth conductor.
- Only use a mains power cord with a current rating as specified by the calibrator and which is approved for the voltage and plug configuration in your area.
- Before switching on the calibrator make sure that it is set to the voltage of the mains electricity supply.
- **Always** position the calibrator to enable easy and quick disconnection of the power source (mains inlet socket).
- The calibrator **must** be kept clear within an area of 20 cm on all sides and 1 metre above the calibrator due to fire hazard.
- **Never** use heat transfer fluids such as silicone, oil, paste, etc. in the calibrators. These fluids may penetrate the calibrator and cause electrical hazard, damage or create poisonous fumes.



Note...

The instrument must **not** be exposed to draughts. Especially the temperature of the target unit surface on the ETC-400 R might be affected by this.

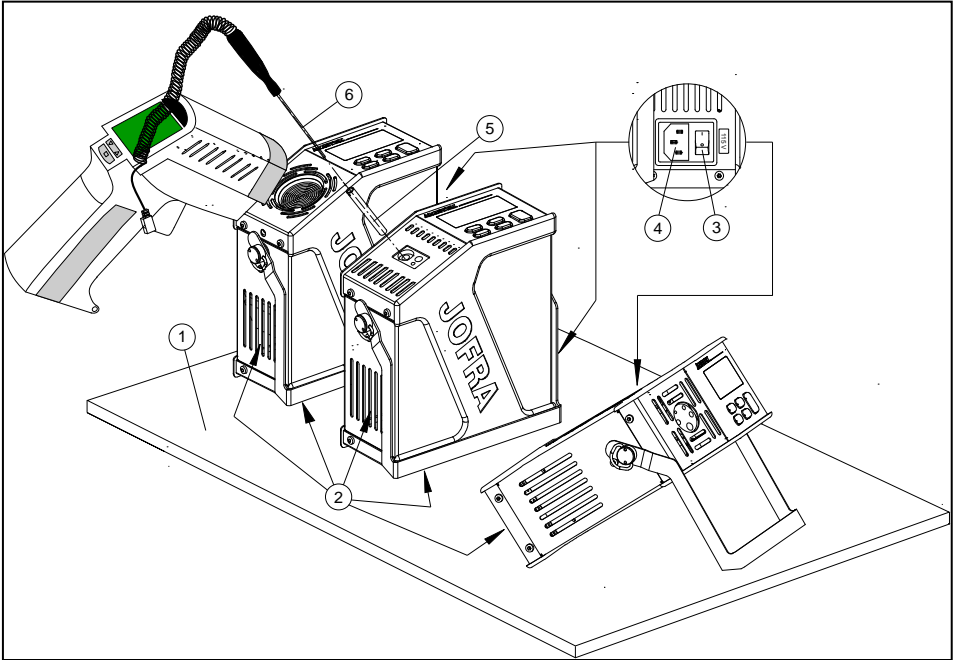

Fig. 1

When setting up the calibrator, you must...(see fig. 1)

- ① Place the calibrator on an even horizontal surface in the spot you intend to use it.



Caution...

Do not use the instrument if the fan is out of order.

- ② Ensure a free supply of air to the fan.
- ③ Check that the voltage shown on the label above the power control switch is identical to the mains voltage (ETC-400 A/R only). If not, the instrument should be returned to AMETEK Denmark A/S or the distributor for replacement.
- ④ Check that the earth connection for the instrument is present and attach the cable.
- ⑤ Select an insertion tube with the correct bore diameter and place it in the largest bore of the instrument (ETC-125 A only) or use one of the bores in the well that best suits your needs. See section 3.3 for information on how to select the insertion tube/ correct bore in the well.

The calibrator is now ready for use.

Section 3.3 and 3.4 are for ETC-125 / 400 A only

3.3 Choice of insertion tube / correct bore in well.



Caution...

To get the best results out of your calibrator, the insertion tube dimensions, tolerance and material are critical. We highly advise using the JOFRA insertion tubes, as they guarantee trouble free operation. Use of other insertion tubes may reduce performance of the calibrator and cause the insertion tube to get stuck.



Caution...

Before using new insertion tubes for calibration in the ETC-125 instrument, the insertion tubes **must** be heated up to maximum temperature 125°C (257°F) for a period of minimum 30 minutes.

Insertion tubes are only available for the ETC-125 A.

An insertion tube is selected on the basis of the diameter of the sensor to be calibrated. You may choose between an 8 mm / 5/16 inch insertion tube, an 3/8 inch insertion tube or alternatively, you may order an undrilled insertion tube and drill the required hole yourself. The finished dimension should be as follows:

- Sensor diameter +0.2 +0.05/-0 mm.

A bore is selected on the basis of the diameter of the sensor to be calibrated. The sensor can now be inserted directly into the bore of the well. See Fig. 2 for various design combinations.

The various design combinations to choose from.

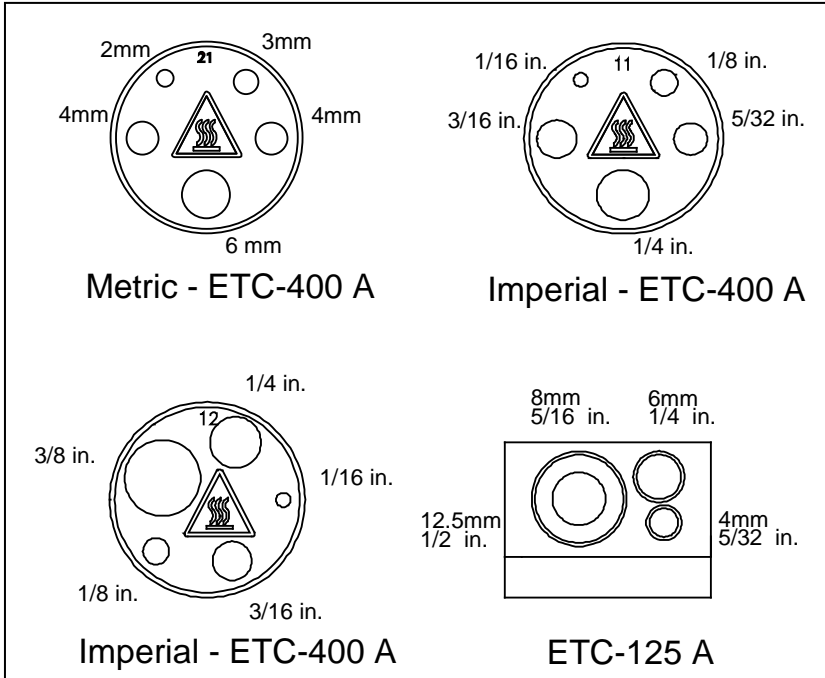

Fig. 2

3.4 Inserting the sensor

Before inserting the sensor and switching on the calibrator, please note the following important warning:



Warning

Never use heat transfer fluids such as silicone, oil, paste, etc. These fluids may penetrate the calibrator and cause electrical hazard, damage or create poisonous fumes.

Insert the sensor as shown in Fig. 1, pos. 6.



Caution...

- The well and the insertion tube **must** be clean before use.
- Scratches and other damage to the insertion tube should be avoided by storing the insertion tube carefully when not in use.
- The insertion tube must **never** be forced into the well. The well could be damaged as a result, and the insertion tube may get stuck.



Caution – Hot surface

- **Do not touch** the grid plate, the well or the insertion tube while the calibrator is heating up – they may be very hot and cause burns.
- **Do not touch** the tip of the sensor when it is removed from the insertion tube – it may be very hot and cause burns.
- **Do not** remove the insert from the calibrator before the insert has cooled down to less than 50°C/122°F.



Caution – Cold surface

Below 0°C/32°F (applies only to the ETC-125 A models)

- **Do not** touch the well or insertion tube when these are below 0°C/32°F - they might create frostbite.
- If the calibrator has reached a temperature below 0°C/32°F, ice crystals may form on the insertion tube and the well. This, in turn, may cause the material surfaces to oxidize
To prevent this from happening, simply heat up the calibrator to 100°C/212°F until all water left has evaporated.

4.0 Operating the calibrator

4.1 Keyboard, display and connections

Keyboard

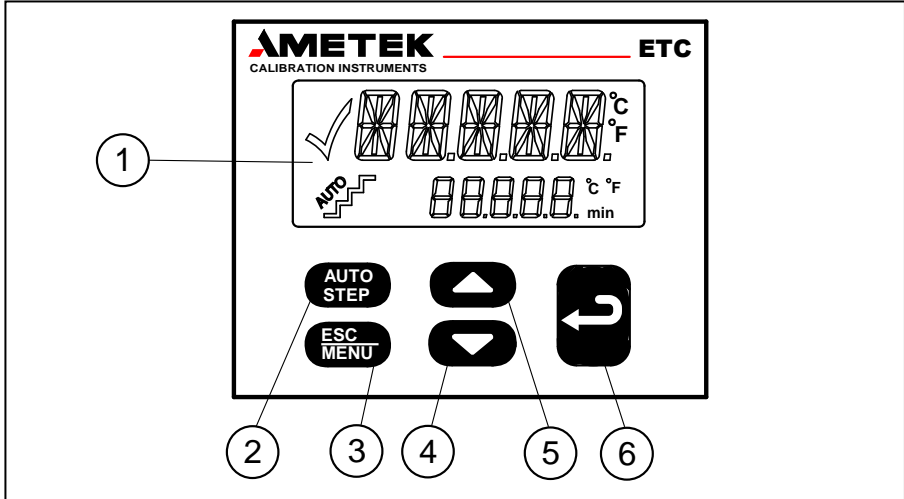

Fig. 3

Pos.	Description
------	-------------

- | | |
|---|---|
| ① | LCD. |
| ② | AUTO STEP button used to activate AUTO STEP. The function is used to switch between a series of set-temperatures automatically. |
| ③ | ESC/MENU button used as Escape key or to activate the menu system (hold button down for min. 2 seconds). |
| ④ | DOWN ARROW button used to adjust temperature values (value decreases) and to select menu options. |
| ⑤ | UP ARROW button used to adjust temperature values (value increases) and to select menu options. |
| ⑥ | ENTER button used to accept chosen options. |

Display

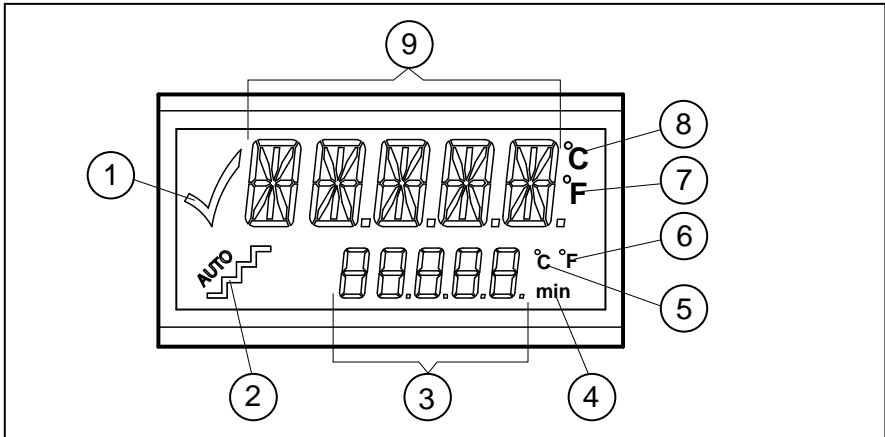

Fig. 4

Pos.	Description
------	-------------

- | | |
|---|--|
| ① | CHECKMARK displayed when the calibrator is stable. |
| ② | AUTO STEP symbol used to indicate that the function is active (symbol flashes repeatedly). |
| ③ | Used to display set-temperatures, time-until-stable and parameter values in the menu system. |
| ④ | Minute time unit for bottom display. |
| ⑤ | Celsius temperature unit for bottom display. |
| ⑥ | Fahrenheit temperature unit for bottom display. |
| ⑦ | Fahrenheit temperature unit for top display. |
| ⑧ | Celsius temperature unit for top display. |
| ⑨ | Used to display Read-temperature and parameters in the menu system. |

Connections

All connections are located on the back of the instrument.

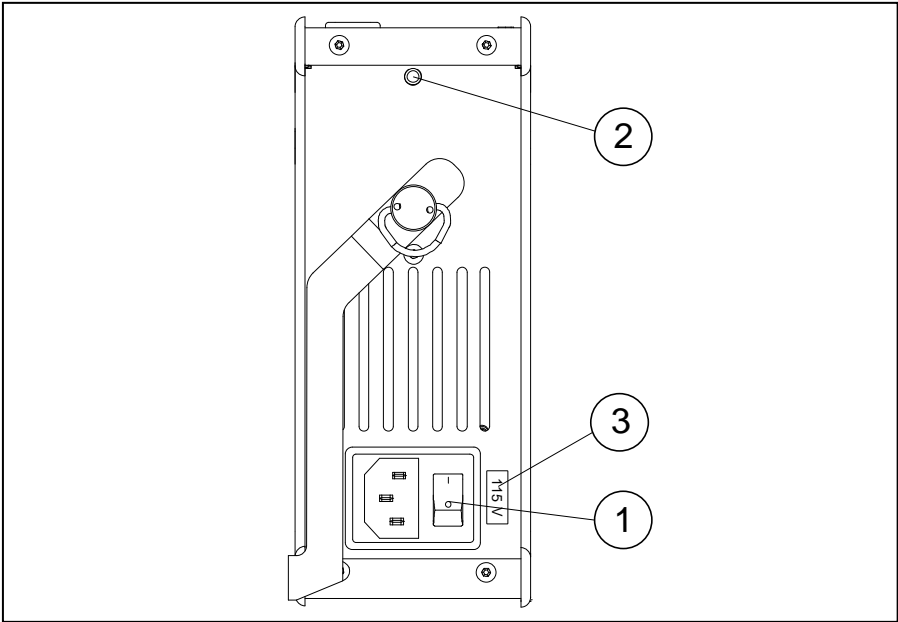

Fig. 5

Pos.	Description
------	-------------

- | | |
|---|---|
| ① | Power control switch with connection for cable and on/off switch. |
| ② | Connection for RS232 cable. |
| ③ | Voltage label. |

It is very important that the voltage shown on the label is identical to the mains voltage.

4.2 Starting the calibrator



Switch the calibrator on using the power control switch (Fig. 5, pos. 1).

The instrument is initialised and the last calibration date is displayed:





The calibration date will be displayed for approx. 2 seconds. The initialisation process has been completed and the calibrator is ready for use.

All settings are stored when the calibrator is switched off. When the instrument is switched back on again, the status will be the same as when it was switched off.

4.3 Selecting the set-temperature



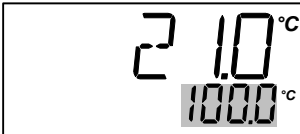

Press  or  to adjust the set-temperature.

The current selection flashes in the bottom display:



The starting point is the last chosen set-temperature (even if the instrument has been switched off).



Press  to accept the change or  to cancel.

The calibrator will now heat up/cool down.

The top display continuously shows the read-temperature. The bottom display shows either the set-temperature or the estimated time in whole minutes until the calibrator will be stable:

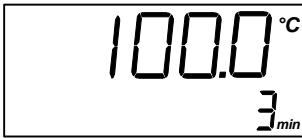

When the calibrator is stable the display will show the checkmark symbol. The instrument will emit an audible alarm and the estimated time until stable will be replaced by the set-temperature:



4.4 Using the AUTO STEP

AUTO STEP is used to step automatically between a range of different calibration temperatures. This is useful when calibrating sensors in places which are hard to reach, and when calibrating sensors for which the output is displayed in a different location.

The function can be illustrated using the following example:

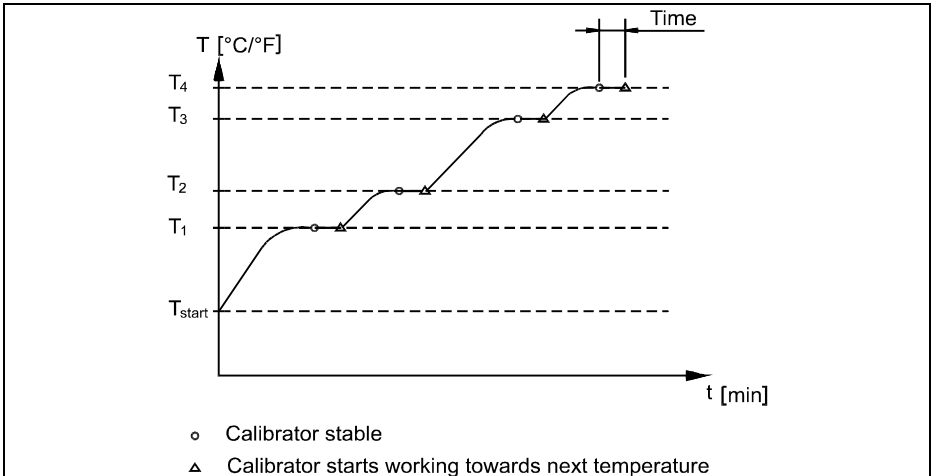

Fig. 6



Press **AUTO STEP**.

The  symbol for AUTO STEP flashes to indicate that the function is active.





The function can be cancelled at any time by pressing **ESC MENU**.

Press  or  to select the required number of steps (minimum 2 steps, maximum 8 steps):



Press  to accept your selection.

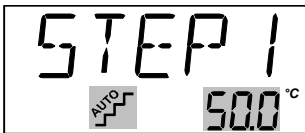

Press  or  to select the required set-temperature for step 1:



Press  to accept your selection.

Repeat the above procedure for all temperature steps.

Press  to accept your choices once you have adjusted the last temperature step.

Press  or  to set the amount of extra time you wish the calibrator to remain at every step:



Press  to accept your selection.

The following will be displayed for one second to indicate that the calibrator is ready to work towards the set-temperature:

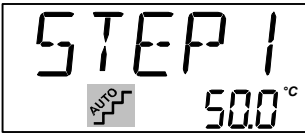

The calibrator will now work towards the given set-temperature. An audible alarm will be emitted once the calibrator is stable.

The calibrator will wait the specified amount of extra time. The instrument indicates this by counting down the amount of time remaining:



The calibrator will then go to the next step. The procedure is the same as for the first step. This process will be repeated until the last step has been executed and the function has been completed.

4.5 Using the MENU

➡ Hold down  for more than approx. 2 seconds:

SETUP

➡ Press  to select SETUP.

➡ Press  or  to switch between the adjustable parameters:

TEMP.
Unit

↑↓

T-MAX.

↑↓

STABL.
Add

↑↓

RESOL.

➡ If you wish to exit SETUP, simply press  .

➡ The instrument will ignore all changes if you press  when adjusting any of the parameters.

➡ Press  to adjust the parameter.

4.5.1 Adjusting the temperature unit

➡ Press  or  to switch between °C and °F:

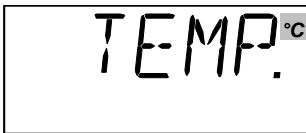



- and



➡ Press  to accept your selection.

4.5.2 Adjusting the max-temperature

Press  or  to set the max-temperature in steps of 0.1°C or 0.1°F:



If the current set-temperature is higher than the new max-temperature, you will need to adjust the set-temperature. The instrument will immediately begin to cool (if required) as soon as the new max-temperature is accepted.

Press  to accept your selection.

If you wish to exit SETUP, simply press .

4.5.3 Adjusting the extra stability time

The extra stability time is the amount of extra time you wish to elapse before the checkmark symbol ✓ is displayed after the calibrator has stabilised.

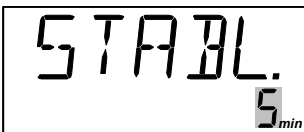

Press  or  to set the time to anywhere between 0 and 20 minutes:



Press  to accept your selection.

4.5.4 Adjusting the temperature resolution



Press  or  to select the required number of decimals:



- and



Press  to accept your selection.



4.6 Calibrating IR-thermometers (ETC-400 R only)



Warning

- **Do never** allow any foreign material to come in contact with the target unit surface, as the emission factor of the target unit might change.
- **Do not touch** the target unit surface and the grid plate – they may be very hot and cause burns.



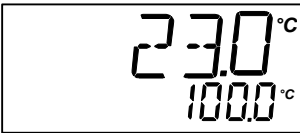

Press  or  to select the required test-temperature.



The starting point is the last chosen test-temperature (even if the instrument has been switched off).



Press  to accept the change or  to cancel.

The calibrator will now heat up/cool down.

The top display continuously shows the read-temperature. The bottom display shows that the calibrator is working towards the given test-temperature.

When the calibrator is stable, the display will show the checkmark symbol. The instrument will emit an audible alarm and the calibrator is now ready for use. ✓



Select the emission factor of the target unit on the IR thermometer to be calibrated. If your IR-thermometer has a fixed emissivity setting, use the IRLAB software to calculate corrections.

Point the IR thermometer perpendicular towards the target unit surface.

It is very important that the thermometer is held close to the target unit surface.

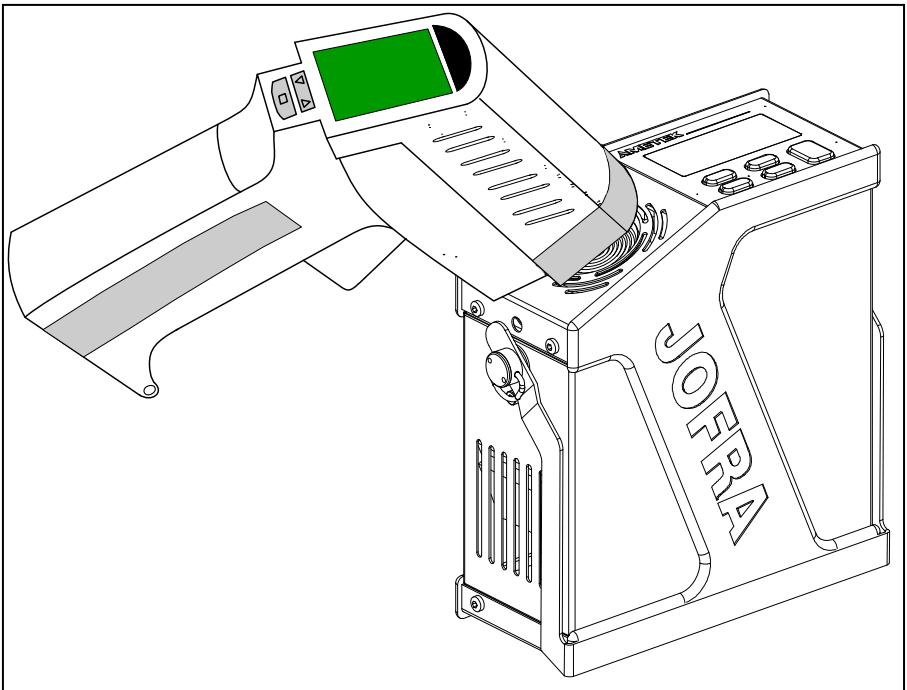

Fig. 7



Caution...

Avoid contact to the target unit surface with the thermometer during operation, as the thermometer accuracy will be affected and the thermometer may overheat or be damaged. Recommended operating distance is between 2,5 – 5 cm / 1 – 2”.

Ensure the thermometer's “field of vision” is centred and contained within the surface area of the target unit. See fig. 7.

If the calibration is not carried out as described, the result of the calibration will not be accurate.

4.7 Simulation/training



Hold down the **AUTO STEP** and  buttons while you switch on the calibrator.

The instrument will display the following screen:



The instrument will then revert to the standard display.

The calibrator's simulation mode is used to train personnel in the use of the instrument, etc. The simulation setting differs from the standard setting as follows:

- The instrument will not actually heat up or cool down the well.
- The heating and cooling processes are simulated at around 10 times the normal speed of these operations.

The calibrator will remain in simulation mode until it is switched off.

5.0 Storing and transporting the calibrator



Caution...

The following guidelines should always be observed when storing and transporting the calibrator. This will ensure that the instrument and the sensor remain in good working order.

Switch off the calibrator using the power control switch. Note that the calibration procedure may be interrupted at any time using the power control switch. Switching off the calibrator during the calibration process will **not** damage either the instrument or the sensor.

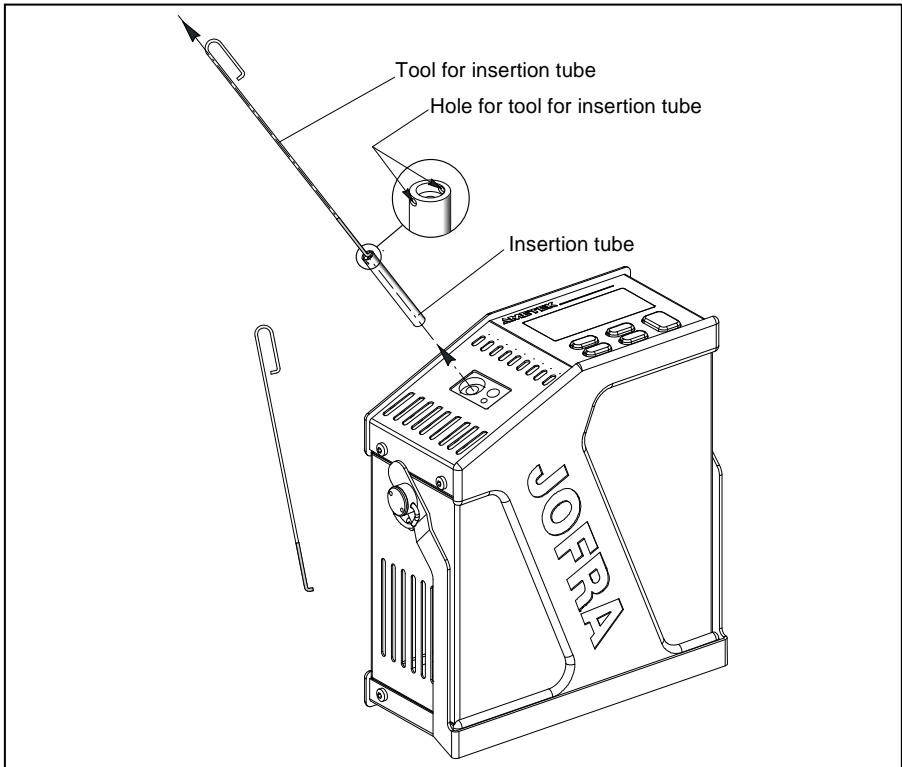

Fig. 8

ETC-125 A only.

The following routine must be observed **before the insertion tube is removed** and the instrument switched off:



Caution – Hot surface

- **Over 50°C/122°F**

If the calibrator has been heated up to temperatures above 50°C/122°F, you must wait until the instrument reaches a temperature **below 50°C/122°F** before you switch it off.

- **Do not** remove the insertion tube from the calibrator before the insertion tube has cooled down to less than 50°C/122°F
- **Never** leave hot insertion tubes which have been removed from the calibrator unsupervised – unauthorized personnel might pick up insertion tubes causing severe burns.
- **Never** place a hot insertion tube in the optional carrying case.



Below 0°C/32°F

- **Do not** touch the well or insertion tube when these are below 0°C/32°F - they might create frostbite.
- If the calibrator has reached a temperature below 0°C/32°F, ice crystals may form on the insertion tube and on the well. This, in turn, may cause the material surfaces to oxidize.

To prevent this from happening, the insertion tube and the well must be dried. This is done by heating up the calibrator to min. 100°C/212°F until all water left has evaporated.

It is very important that humidity in the well and insertion tube is removed to prevent corrosion and frost expansion damages.

Remove the insertion tube from the calibrator using the tool for insertion tube supplied with the instrument as shown in Fig. 8.



Caution...

- The insertion tube must **always** be removed from the calibrator after use.
The humidity in the air may cause corrosion oxidation on the insertion tube inside the instrument. There is a risk that the insertion tube may get stuck if this is allowed to happen.
- The insertion tube **must** be removed to avoid damage to the instrument if the calibrator is to be transported long distances.

ETC-400 R only

When the ETC-400 R is not in use, it is advisable to store the calibrator in the carrying case.



Caution – Hot surface

- **Over 50°C/122°F**
If the calibrator has been heated up to temperatures above 50°C/122°F, you must wait until the instrument reaches a temperature **below 50°C/122°F** before you switch it off.
- You **must** ensure that the instrument has cooled down to a temperature **below 100°C/212°F** before placing it in the carrying case.

6.0 Errors



Warning

The calibrator **must** be switched off before any attempt to service the instrument is made. There are no user serviceable parts inside the calibrator.



Note...

AMETEK Denmark's liability ceases if:

- parts are replaced/repaired using spare parts which are not identical to those recommended by the manufacturer.
- non-original parts are used in any way when operating the instrument.

AMETEK Denmark's liability is restricted to errors which originated from the factory.

If the calibrator detects an error during operation, the instrument will terminate all functions and display an error code:



Likely cause: Defective RTD-sensor or excessively high temperature measured by the instrument's internal sensor.

Solution: The calibrator should be returned to the manufacturer for service.



Likely cause: The calibration coefficients have not been accepted.

Solution: Try again. If the error message returns, the calibrator should be returned to the manufacturer for service.



Likely cause: An error has occurred in the control circuit.

Solution: The calibrator should be returned to the manufacturer for service.

Nothing happens when the power control switch (on/off switch) is pressed.

Likely cause: There is no power to the calibrator.

Solution: Check that the calibrator is correctly connected. If there are no problems with the mains cable, the calibrator should be returned to the manufacturer for service.

7.0 Returning the calibrator for service

When returning the calibrator to the manufacturer for service, please enclose a fully completed service information form. Simply copy the form on the following page and fill in the required information. The calibrator should be returned in the original packing.

Service info

Customer data:

Date:

Customer name and address: _____

Attention and Dept.: _____

Fax no./Phone no.: _____

Your order no.: _____

Delivery address: _____

Distributor name: _____

Instrument data:

Model and Serial no.: _____

Warranty claimed Yes: ____ No: ____ Original invoice no.: _____

Temp.
calibration

Service request:

**This instrument is sent for
(please check off):**

- | | | |
|--------------------------|---|--------------|
| <input type="checkbox"/> | ____ Calibration as left | ____ Check |
| <input type="checkbox"/> | ____ Calibration as found and as left | ____ Service |
| <input type="checkbox"/> | ____ Accredited calibration as left | ____ Repair |
| <input type="checkbox"/> | ____ Accredited calibration as found and as left. | |

Diagnosis data/cause for return:

Diagnosis/Fault description: _____

Special requests: _____

Safety precautions: if the product has been exposed to any hazardous substances, it must be thoroughly decontaminated before it is returned to AMETEK. Details of the hazardous substances and any precautions to be taken must be enclosed.

8.0 Maintenance

8.1 Cleaning



Caution...

Before cleaning the calibrator, you **must** switch it off, allow it to cool down and remove all cables.



Caution – Hot surface

- **Over 50°C/122°F**

If the calibrator has been heated up to temperatures above 50°C/122°F, you must wait until the instrument reaches a temperature **below 50°C/122°F** before you switch it off.



Caution – Hot surface – ETC-125 A only

- **Do not** remove the insertion tube from the calibrator before the insertion tube has cooled down to less than 50°C/122°F
- **Never** leave hot insertion tubes which have been removed from the calibrator unsupervised – unauthorized personnel might pick up insertion tubes causing severe burns.
- **Never** place a hot insertion tube in the optional carrying case.



Below 0°C/32°F

- **Do not** touch the well or insertion tube when these are below 0°C/32°F - they might create frostbite.
- If the calibrator has reached a temperature below 0°C/32°F, ice crystals may form on the insertion tube and on the well. This, in turn, may cause the material surfaces to oxidize.

To prevent this from happening, the insertion tube and the well must be dried. This is done by heating up the calibrator to min. 100°C/212°F until all water left has evaporated.

It is very important that humidity in the well and insertion tube is removed to prevent corrosion and frost expansion damages.



Caution – ETC-125 A only

The insertion tube must **always** be removed from the calibrator after use.

The humidity in the air may cause corrosion oxidation on the insertion tube inside the instrument. There is a risk that the insertion tube may get stuck if this is allowed to happen.

Users should/must carry out the following cleaning procedures as and when required:

- **The exterior of the instrument** - Clean using water and a soft cloth.
The cloth should be wrung out hard to avoid any water penetrating the calibrator and causing damage.
The keyboard may be cleaned using isopropyl alcohol when heavily soiled.
- **The insertion tube (ETC-125 A only)** - Must **always** be clean and should be regularly wiped using a soft, lint-free, dry cloth. You must ensure there are no textile fibres on the insertion tube when it is inserted in the well. The fibres may adhere to the well and damage it.
- **The well** - Must **always** be clean. Dust and textile fibres should be removed from the well using e.g. compressed air.



Warning

REMEMBER to wear goggles when using compressed air!

- **The target unit surface (ETC-400 R only)** - Must **always** be clean. Dust and textile fibres should carefully be blown from the surface with clean air. **Do not** use fluid to clean the target unit surface.

If it is impossible to clean the surface with clean air only the target unit could alternatively be heated up to max. temperature. The dust and fibres will then be burned off the surface. There is, however, the risk that the dust and fibres could permanently burn into the surface, altering the emission factor.

8.2 Adjusting and calibrating the instrument

You are advised to return the calibrator to AMETEK Denmark A/S or an accredited laboratory at least once a year for calibration and adjustment.

Alternatively, you can calibrate/adjust the calibrator yourself. You will need a reference thermometer and a reference sensor with a traceable calibration certificate. Please follow the instructions given below.

Connect the calibrator to an external precision instrument (e.g. a DTI) as shown in Fig. 9:

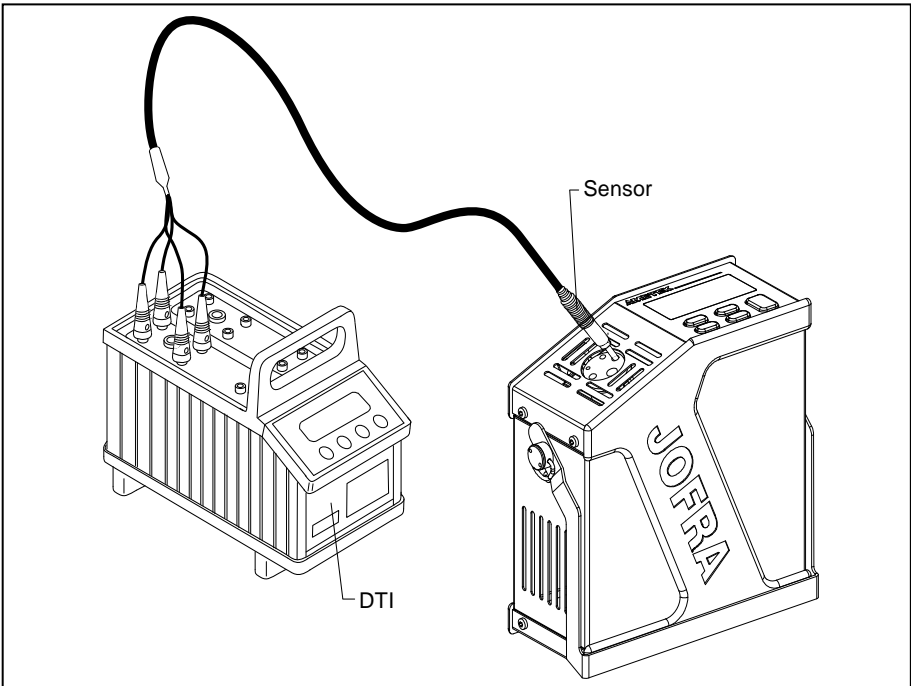



Fig. 9



Hold down the **ESC MENU** button while pressing the on/off power control switch.

The instrument is now in adjustment/service mode.



Press  or  to toggle between the different options:

SOFTW.
10



DATE
CAL.



CALIB.
PROC.



SN.
12345



Press  to accept your selection.

To exit the adjustment/service mode, switch the instrument off and on again using the power control switch.



8.2.1 Adjusting the calibration date

Adjust the date by toggling through the available days, months and years. Begin by selecting the required day as shown below:

Press  or  to select the required day in the interval 1-31.



Press  to accept your selection.

Press  or  to select the required month from JAN / FEB / MAR / APR / MAY / JUN / JUL / AUG / SEP / OCT / NOV / DEC.



Press  to accept your selection.

Press  or  to select a year between 2002–2025.



➡ Press  to accept your selection. The day will be adjusted if necessary to ensure the legality of the date. Finally, the day, month and year will flash:



➡ Press  to accept the date.

or

➡ press  to cancel the whole selection.

8.2.2 Calibrating/adjusting the instrument

The internal calibration/adjustment is a complex function which is divided into a number of different steps:

The instrument will disclose the first calibration temperature by displaying the text “TEMP.1 XXX°C” for approx. 1 second:

Calibration temperature for calibrators:

ETC-125 A	1.	-8°C / 17.6°F
	2.	0°C / 32°F
	3.	50°C / 122°F
	4.	100°C / 212°F
	5.	125°C / 257°F

- ETC-400 A / R
1. 50°C / 122°F
 2. 100°C / 212°F
 3. 200°C / 392°F
 4. 300°C / 572°F
 5. 400°C / 752°F

The instrument will now heat up/cool down to reach the first calibration temperature:

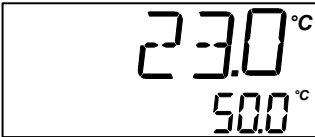

Once the calibrator is stable, you need to enter the reference temperature found using the reference thermometer. The calibration temperature is suggested as a reference point:



This procedure is repeated for TEMP.2, TEMP.3, TEMP.4 and TEMP.5.

All five calibration temperatures and associated reference temperatures have now been entered.

The instrument will now check whether the reference temperatures which have been entered are within the permitted tolerances.

Permitted tolerances:



- ETC-125 A / 400 A / 400 R : $\pm 0,2^{\circ}\text{C}$ / 0.36°F

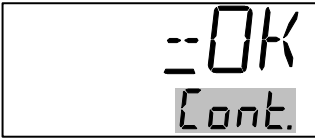

If the calibrator is found to be within the permitted tolerances, the instrument will display the text =OK at the top of the display. The text Cont. will flash in the bottom of the display to indicate that you may continue without adjustments:

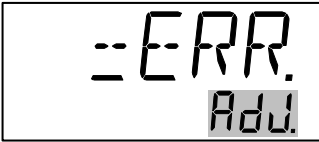





If the instrument detects excessive deviations for one or more steps, it will show a screen reading =ERR. in the top of the display. The text AdJ. will flash in the bottom of the display to indicate that an adjustment is required. Accept by pressing .



-  Press  to cancel the adjustment function.

-  Press  to go back to a previous screen and press  to repeat an adjustment step when it is shown on the display.

-  Press  to toggle between AdJ. and Cont. on the display.

-  Press  when AdJ. is flashing to calculate a new set of coefficients. Next, repeat the entire calibration/adjustment procedure.

If the new coefficients deviate by more than 4% from the standard values, the instrument will display an ERROR 2 in the display. The calculated coefficients will be ignored:



Press  to repeat the entire calibration/adjustment procedure.



Press  when Cont. is flashing to end the calibration/adjustment procedure and enter a new calibration date (see section 8.2.1).

8.2.3 Calibrating/adjusting the ETC-400 R

In order to calibrate the inner thermometer of the calibrator, a 3 mm insertion hole for the reference sensor has been drilled 1 mm beneath the target unit surface. See fig. 10.

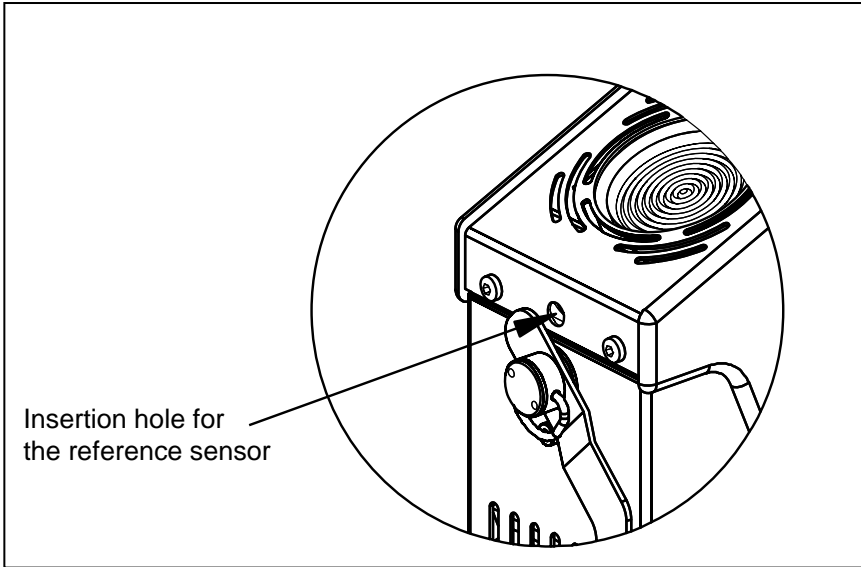

Fig. 10

For the calibration it is recommendable to use the RTD reference sensor 65-Pt100-150 SPEC. which AMETEK DENMARK A/S has developed specifically for this instrument.

In principle any sensor fitting the insertion hole is useable, however, there is the risk of incorrect temperature reading due to the limited insertion depth of the reference sensor hole.

9.0 Technical specifications

The illustration below shows the setup which forms the basis for the technical specifications. In this case an ETC-400 A.

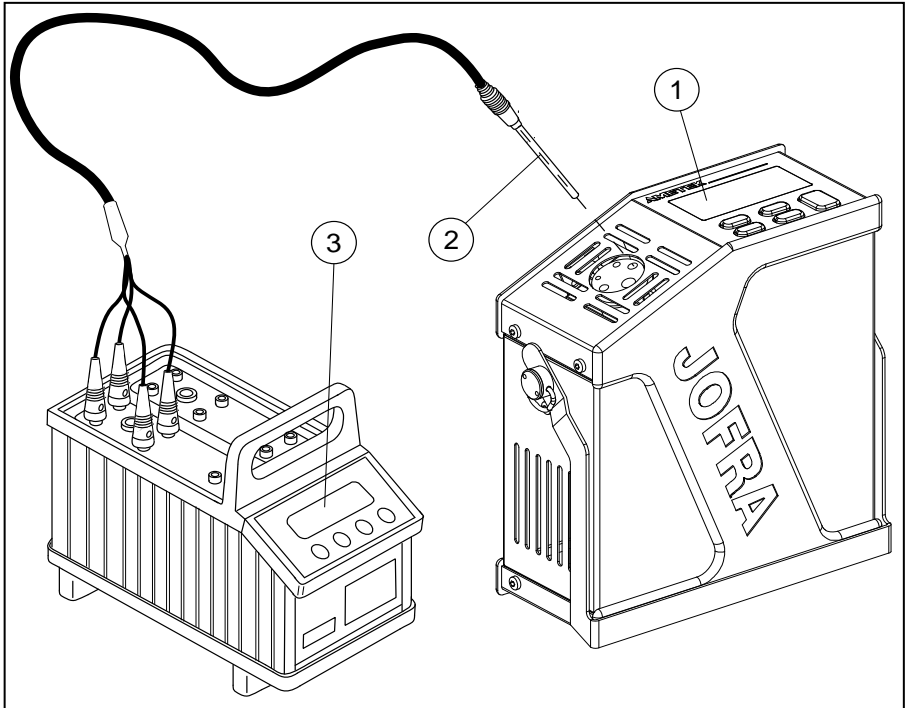

Fig. 11

Pos.	Description
①	Calibrator
②	ø4 mm Pt 100 sensor with traceable certificate (ETC-125/400 A) ø3mm Pt 100 sensor with traceable certificate (ETC-400 R)
③	DTI 1000 reference precision thermometer with traceable certificate

Thermal specifications

All specifications are given with an ambient temperature of 23°C/73.4°F ± 3°C/5.4°F.

¹ Measured at the bottom of the well with a 4 mm sensor

² Specified at 115V / 230V

Specifications

Model

ETC-125 A

Max. temperature :	125°C / 257°F
Min. temperature :	-18°C / -0.4°F @ ambient temperature 0°C / 32°F -10°C / 14°F @ ambient temperature 23°C / 73.4°F 6°C / 42.8°F @ ambient temperature 40°C / 104°F
Well specifications :	40 mm / 1.57 in. axial homogeneity : 0.30°C / 0.54°F @ -10°C / 14°F 0.85°C / 1.53°F @ 125°C / 257°F 60 mm / 2.36 in. axial homogeneity : 0.30°C / 0.54°F @ -10°C / 14°F 0.85°C / 1.53°F @ 125°C / 257°F Difference between borings : 0.40°C / 0.72°F Influence from load : 0.10°C / 0.18°F @ -10°C / 14°F 0.20°C / 0.36°F @ 125°C / 257°F
Display resolution :	1° or 0.1°C / 1.8° or 0.18°F
Stability :	±0.05°C / ±0.09°F
Accuracy ¹ :	±0.5°C / ±0.9°F
Heating time ² :	-10 to 23°C / 14 to 73°F : 3 min. 23 to 100°C / 73 to 212°F : 11 min. 100 to 125°C / 212 to 257°F : 7 min.

ETC-125 A

Time to stability:	3 minutes
Cooling time :	125 to 100°C / 257 to 212°F : 1 min.
	100 to 0°C / 212 to 32°F : 17 min.
	0 to -10°C / 32 to 14°F : 14 min.

ETC-400 A

Max. temperature :	400°C / 752°F
Min. temperature :	5°C / 41°F @ ambient temperature 0°C / 32°F
	28°C / 82.4°F @ ambient temperature 23°C / 73.4°F
	45°C / 113°F @ ambient temperature 40°C / 104°F
Well specifications :	40 mm / 1.57 in. axial homogeneity :
	0.85°C / 1.53°F @ 180°C / 356°F
	1.00°C / 1.8°F @ 400°C / 752°F
	Difference between borings :
	0.40°C / 0.72°F
	Influence from load :
	0.30°C / 0.54°F @ 400°C / 752°F
Display resolution :	1° or 0.1°C / 1.8° or 0.18°F
Stability :	±0.15°C / ±0.27°F
Accuracy ¹ :	±0.5°C / ±0.9°F
Heating time ² :	28 to 200°C / 82 to 392°F : 2 min.
	200 to 400°C / 392 to 752°F : 3 min.
Time to stability:	3 minutes
Cooling time :	400 to 200°C / 752 to 392°F : 6 min.
	200 to 50°C / 392 to 122°F : 15 min.

ETC-400 R

Max. temperature :	400°C / 752°F
Min. temperature :	5°C / 41°F @ ambient temperature 0°C / 32°F 28°C / 82.4°F @ ambient temperature 23°C / 73.4°F 45°C / 113°F @ ambient temperature 40°C / 104°F
Display resolution :	1° or 0.1°C / 1.8° or 0.18°F
Stability :	±0.3°C / ±0.54°F
Accuracy :	±0.5°C / ±0.9°F
Accuracy incl. emissivity :	±0.4% rdg. ±1°C / ±0.4% rdg. ±1.8°F
Heating time ² :	28 to 200°C / 82 to 392°F : 2 min. 200 to 400°C / 392 to 752°F : 3 min.
Time to stability:	3 minutes
Cooling time :	400 to 200°C / 752 to 392°F : 9 min. 200 to 50°C / 392 to 122°F : 24 min.
Emissivity :	0.96

Electrical specifications

Specifications	Model
	ETC-125 A
Power supply [VAC]:	Multivoltage 115VAC and 230VAC, 47-63Hz
	115 V (90-132) and 230 V (180-264)
Power consumption (max.):	75 VA
	ETC-400 A / R
Power supply [VAC],	
115VAC, 45-65Hz :	90-127
230VAC, 45-65Hz :	180-254
Power consumption (max.):	350 W

Mechanical specifications

Specifications	Model
	ETC-125 A
Weight :	1.75 kg. / 3.86 lb.
Dimensions	
LxWxH :	172 x 72 x 182 mm / 6.8 x 2.8 x 7.2 inch
Operating temp. :	0 to 40°C / 32 to 104°F
Storage temp. :	-20 to 50°C / -4 to 122°F
Humidity range :	0 to 90% RH
Protection class :	IP10

ETC-400 A / R

Weight	:	1.58 kg. / 3.5 lb. (ETC-400 A) 1.7 kg. / 3.7 lb. (ETC-400 R)
Dimensions LxWxH	:	172 x 72 x 182 mm / 6.8 x 2.8 x 7.2 inch
Operating temp.	:	0 to 40°C / 32 to 104°F
Storage temp.	:	-20 to 50°C / -4 to 122°F
Humidity range	:	0 to 90% RH
Protection class	:	IP10

STANDARDS – ALL MODELS

The following standards are observed according to the EMC-Directive (2014/30/EU)

EN 61326-1: 2013: Electrical equipment for measurement, control and laboratory use – EMC requirements.

The following standards are observed according to the low voltage-directive (2014/35/EU)

EN61010-1:2010 : Safety requirements for electrical equipment for measurement, control and laboratory use, part 1: General requirement

10.0 List of accessories

All parts listed in the list of accessories can be obtained from the factory through our dealers.

Please contact your dealer for assistance if you require parts which do not appear on the list.

List of accessories

Accessories	Parts no.
User and reference manual	123943
Tool for insertion tube (ETC-125 A only)	60F172
Aluminium carrying case	124094
Mains cable, 115V, US, type B	60F135
Mains cable, 240V, UK, type C	60F136
Mains cable, 220V, South Africa, type D	60F137
Mains cable, 220V, Italy, type E	60F138
Mains cable, 240V, Australia, type F	60F139
Mains cable, 230V, Europe, type A	60F140
Mains cable, 230V, Denmark, type G	60F141
Mains cable, 220V, Switzerland, type H	60F142
Mains cable, 230V, Israel, type I	60F143
RS232 serial cable 2 m	123958
5 x undrilled insertion tubes for ETC-125 A	123939
8 mm / 5/16 inch insertion tube for ETC-125 A	123938
3/8 inch insertion tube for ETC-125 A	124045
Shoulder strap with snap hooks	124004
JOFRACAL PC software	124915
JOFRA IR-LAB calibration software for ETC-400 R	124591
Correction table for emissivity for ETC-400 R	124592
Pt100 sensor \varnothing 3mm x 150mm for ETC-400 R	65-PT100-150 SPEC

AMETEK Sensors, Test & Calibration

A business unit of AMETEK Measurement & Calibration Technologies Division offering the following industry leading brands for test and calibration instrumentation.

JOFRA Calibration Instruments

Temperature Calibrators

Portable dry-block calibrators, precision thermometers and liquid baths. Temperature sensors for industrial and marine use.

Pressure Calibrators

Convenient electronic systems ranging from -25 mbar to 1000 bar - fully temperature-compensated for problem-free and accurate field use.

Signal Instruments

Process signal measurement and simulation for easy control loop calibration and measurement tasks.

M&G Deadweight Testers & Pumps

Pneumatic floating-ball or hydraulic piston dead weight testers with accuracies to 0.015% of reading. Pressure generators delivering up to 1,000 bar.

Crystal Pressure

Digital pressure gauges and calibrators that are accurate, easy-to-use and reliable. Designed for use in the harshest environments; most products carry an IS, IP67 and DNV rating.

Lloyd Materials Testing

Materials testing machines and software that guarantees expert materials testing solutions. Also covering Texture Analysers to perform rapid, general food testing and detailed texture analysis on a diverse range of foods and cosmetics.

Chatillon Force Measurement

The hand held force gauges and motorized testers have earned their reputation for quality, reliability and accuracy and they represent the de facto standard for force measurement.

Newage Hardness Testing

Hardness testers, durometers, optical systems and software for data acquisition and analysis.



www.ametekcalibration.com

United Kingdom

Tel +44 (0)1243 833 302
caluk.sales@ametek.com

France

Tel +33 (0)1 30 68 89 40
general.lloyd-instruments@ametek.fr

Germany

Tel +49 (0)2159 9136 510
info.mct-de@ametek.de

Denmark

Tel +45 4816 8000
jofra@ametek.com

USA

Florida
Tel +1 (800) 527 9999
cal.info@ametek.com

California

Tel +1 (800) 444 1850
crystal@ametek.com

India

Tel +91 22 2836 4750
jofra@ametek.com

Singapore

Tel +65 6484 2388
jofra@ametek.com

China

Shanghai
Tel +86 21 5868 5111

Beijing

Tel +86 10 8526 2111
jofra.sales@ametek.com.cn